

STEEL CLEATS
FORE EMBEDDING
INTO SUBSTRATE X8
(CLEATS ARE SPOT
LOCATED)

STEEL FRAME
(SHOWN WITHOUT
WELDS)

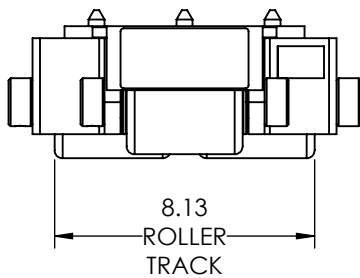

Capacity: 20 Tons Each
Roller Material: Polyurethane Coated
Weight: 74 lbs.
Colorway: Hevi-Haul Red
Country of Origin: United States of America

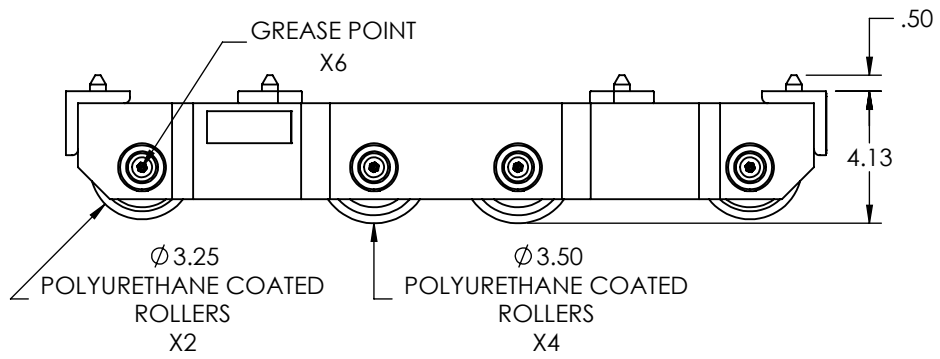
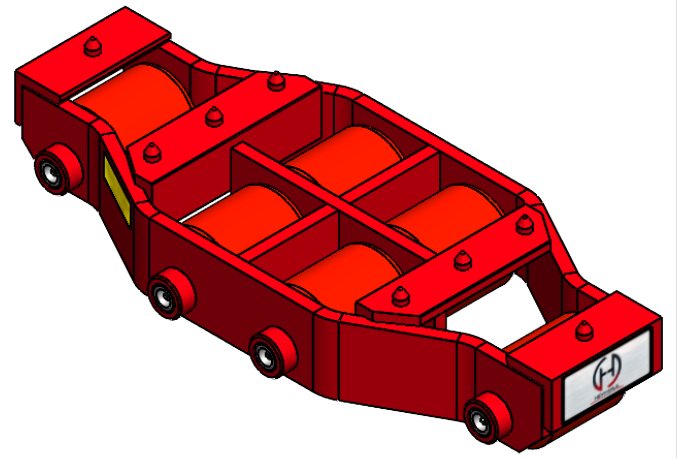
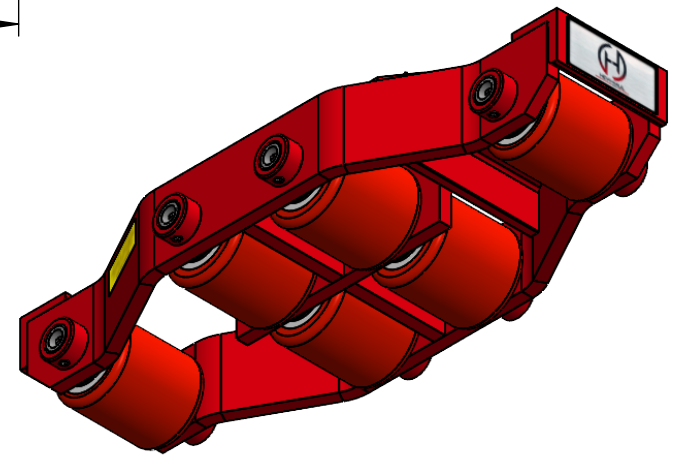
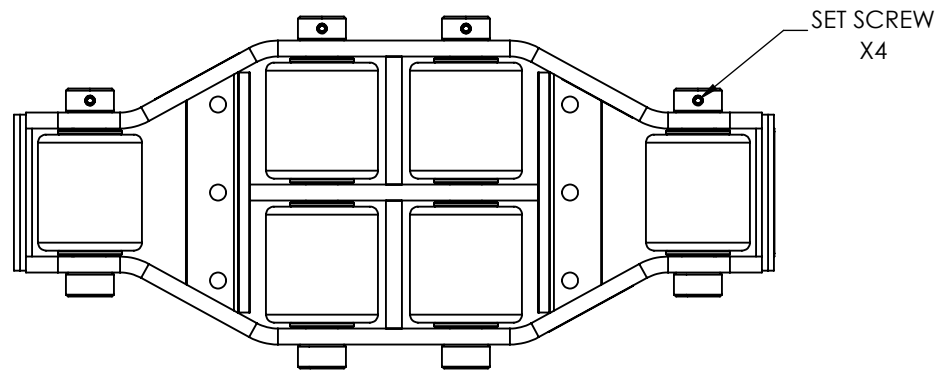

**PLEASE CONTACT US BY PHONE OR
EMAIL IF YOU WOULD LIKE US TO
MODIFY THIS DESIGN. DRAWING IS
SHOWN WITHOUT WELDS.**

HEVI-HAUL
PRODUCTS THAT MOVE THE WORLD
PO Box 580 Menomonee Falls, WI 53052
Phone (262) 502-0333 | hevihaul.com

PROPRIETARY AND CONFIDENTIAL, THE INFORMATION CONTAINED IN THIS DRAWING IS THE SOLE PROPERTY OF HEVI-HAUL. ANY REPRODUCTION IN PART OR AS A WHOLE WITHOUT THE WRITTEN PERMISSION OF HEVI-HAUL IS PROHIBITED.

DIMENSIONS ARE IN INCHES		THIRD ANGLE PROJECTION		DESCRIPTION:	REV:
				SPECIFICATION SHEET	-
SCALE:	DRAWN BY:	DATE:	DWG NO:	SHEET:	
NTS	DMK	3/19/2025	UM-HD-75-P	1 OF 1	