

**Capacity:** 10 Tons Each  
**Roller Material:** Polyurethane Coated  
**Weight:** 64 lbs.  
**Colorway:** Hevi-Haul Red  
**Country of Origin:** United States of America

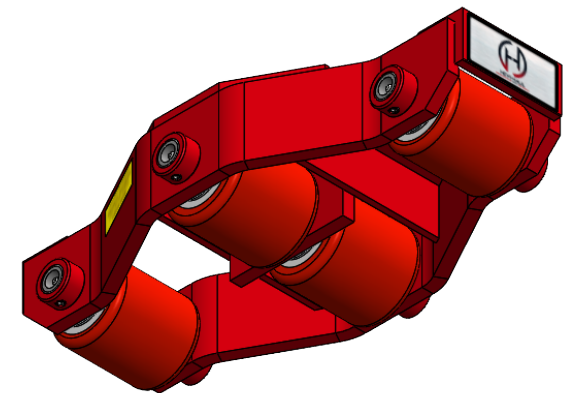
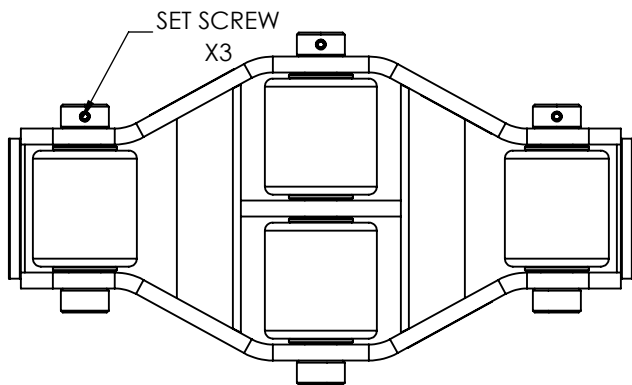

**PLEASE CONTACT US BY PHONE OR EMAIL IF YOU WOULD LIKE US TO MODIFY THIS DESIGN. DRAWING IS SHOWN WITHOUT WELDS.**

**HEVI-HAUL**  
 PRODUCTS THAT MOVE THE WORLD  
 PO Box 580 Menomonee Falls, WI 53052  
 Phone (262) 502-0333 | hevihaul.com

PROPRIETARY AND CONFIDENTIAL, THE INFORMATION CONTAINED IN THIS DRAWING IS THE SOLE PROPERTY OF HEVI-HAUL. ANY REPRODUCTION IN PART OR AS A WHOLE WITHOUT THE WRITTEN PERMISSION OF HEVI-HAUL IS PROHIBITED.

DIMENSIONS ARE IN INCHES		DESCRIPTION:			REV:
THIRD ANGLE PROJECTION		<b>SPECIFICATION SHEET</b>			-
SCALE: NTS	DRAWN BY: DMK	DATE: 3/25/2025	DWG NO: UMS-HD-30-P	SHEET: 1 OF 1	