

Capacity: 15 Tons Each
Roller Material: Steel
Weight: 78 lbs.
Colorway: Hevi-Haul Red
Country of Origin: United States of America

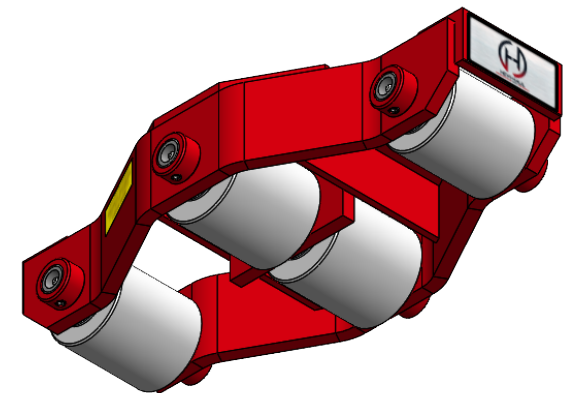
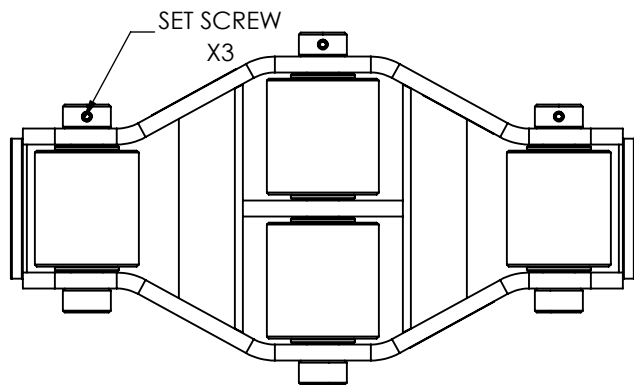

PLEASE CONTACT US BY PHONE OR EMAIL IF YOU WOULD LIKE US TO MODIFY THIS DESIGN. DRAWING IS SHOWN WITHOUT WELDS.

HEVI-HAUL
 PRODUCTS THAT MOVE THE WORLD
 PO Box 580 Menomonee Falls, WI 53052
 Phone (262) 502-0333 | hevihaul.com

PROPRIETARY AND CONFIDENTIAL, THE INFORMATION CONTAINED IN THIS DRAWING IS THE SOLE PROPERTY OF HEVI-HAUL. ANY REPRODUCTION IN PART OR AS A WHOLE WITHOUT THE WRITTEN PERMISSION OF HEVI-HAUL IS PROHIBITED.

DIMENSIONS ARE IN INCHES		DESCRIPTION:			REV:
THIRD ANGLE PROJECTION		SPECIFICATION SHEET			-
SCALE: NTS	DRAWN BY: DMK	DATE: 3/25/2025	DWG NO: UMS-HD-30	SHEET: 1 OF 1	